

Boîte avec membrane élastique

2

Cette nouveauté brevetée, permet d'emballer des objets délicats, ronds, pointus ou difformes de différentes grandeurs, sans risque d'oxydation. La transparence de l'emballage permet un contrôle visuel. Les couvercles et les fonds sont interchangeables. Toutes les boîtes peuvent être personnalisées (logo, adjonction de séparations).





Une boîte avec membrane est composée de 2 demi-boîtes en polystyrol munie d'une membrane très mince en polyuréthane. Les objets se trouveront pincés et suspendus à l'intérieur de la boîte. Des charnières et crochets de fermeture permettent une réutilisation de l'emballage.

La profondeur d'une des demi-boîtes peut être différente de l'autre. Les commandes de ces emballages doivent se faire par demi-boîte, non assemblées, ce qui permet de varier la profondeur de l'emballage selon la forme des pièces à emballer.

Les n° d'articles figurant dans nos listes concernent souvent des demi-boîtes. Il est donc possible de commander une demi-boîte de 100 mm de longueur, 50 mm de large, 8 mm de profondeur avec une demi-boîte de 100 mm de long., 50 mm de large, 25 mm de profondeur. (Pages 3 à 23a)

Les boîtes qui contiennent un objet doivent voyager par avion dans des **soutes pressurisées**.



Boîtes rectangulaires avec membrane		3 - 22
Cadres avec membrane		23a
Boîte à membrane pour montres avec bracelet métallique et cuir		23c
Boîtes en grappe avec membrane		24
Boîtes rondes avec membrane		25
Boîte étanche avec membrane		25a
Cadres pliables avec membrane		25b
Boîte à membrane avec pitons pour 10/20/30 cadrans		25c
Plateaux empilables		26

½ boîte avec membrane élastique

3



Schéma	Longueur (1) mm	Largeur (2) mm	Hauteur (3) mm	Référence	Quantité	
	50	50	8	3		S
			12.5	4		S
	75	50	8	5		S
			12.5	6		S
	75	75	8	7		S
			12.5	8		S
	100	50	8	11		S
			12.5	12.1		S
			25	13		S
	100	75	8	22		S
			12.5	23		S
			25	24		S
			37.5	25		S
	100	100	8	31		S
			12.5	32		S
			25	33		S
			37.5	34		S
			50	35		S
	100	100	8	36		S
			12.5	37		S
			25	38		S
			37.5	39		S
			50	40		
	125	50	8	44		S
			12.5	45		S
			25	46		S
	125	75	8	55		S
			12.5	56		S
			25	57		S
			37.5	58		

- L = Crochet d'ouverture
- C = Charnière
- Les numéros d'article concernent toujours des ½ boîtes
- S = Livrable du stock (sans frais d'outillage)

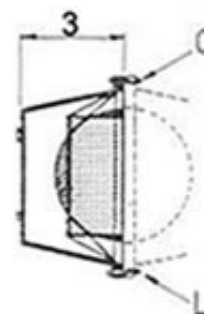
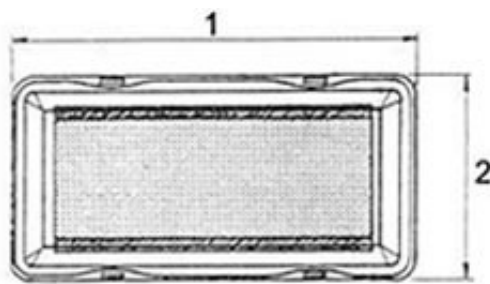
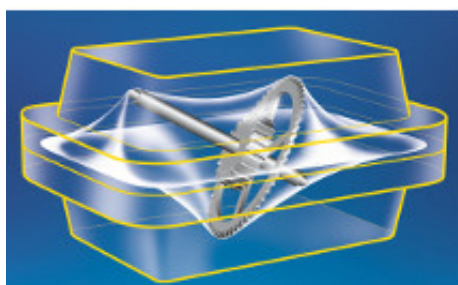

Schéma	Longueur (1) mm	Largeur (2) mm	Hauteur (3) mm	Référence	Quantité	
	125	100	8	74		S
			12.5	75		
			25	76		
			37.5	77		
			50	78		S
	125	125	8	96		S
			12.5	97		S
			25	98		S
			37.5	99		S
			62.5	101		
	125	125	8	102		S
			12.5	103		S
			25	104		S
			37.5	105		
			50	106		S
	150	50	8	114		S
			12.5	115		S
			25	116		S
			8	117		S
			12.5	118		S
	150	75	8	128		
			12.5	129		S
			25	130		S
			37.5	131		

- L = Crochet d'ouverture
- C = Charnière
- Les numéros d'article concernent toujours des ½ boîtes
- S = Livrable du stock (sans frais d'outillage)

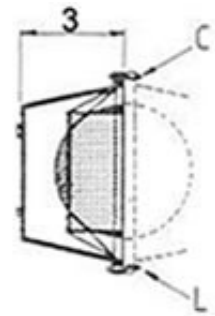
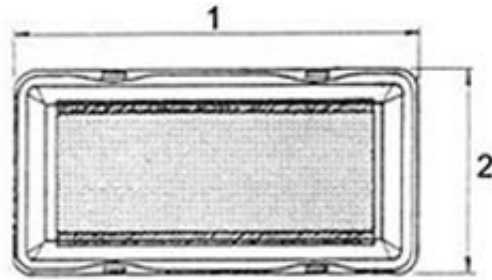
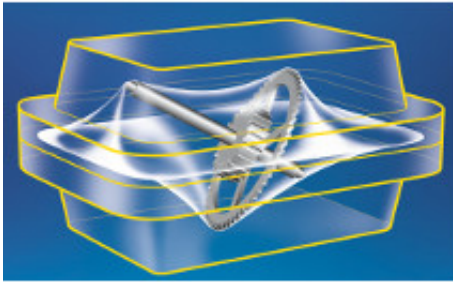

Schéma	Longueur (1) mm	Largeur (2) mm	Hauteur (3) mm	Référence	Quantité	
	150	100	8	147		S
			12.5	148		S
			25	149		S
			37.5	150		S
			50	151		S
	150	100	8	153		S
			12.5	154		S
			25	155		S
			37.5	156		S
			50	157		
	150	125	8	183		S
			12.5	184		S
			25	185		S
			37.5	186		S
			50	187		
			62.5	188		
	150	125	8	195		
			12.5	196		
			25	197		S
			37.5	198		
			50	199		
			62.5	200		

- L = Crochet d'ouverture
- C = Charnière
- Les numéros d'article concernent toujours des ½ boîtes
- S = Livrable du stock (sans frais d'outillage)

½ boîte avec membrane élastique

6

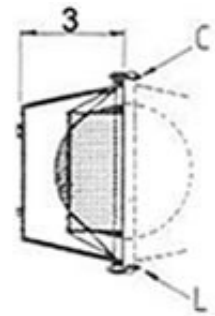
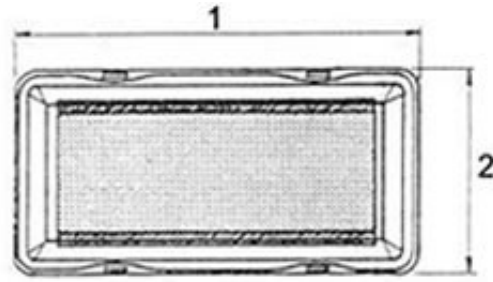
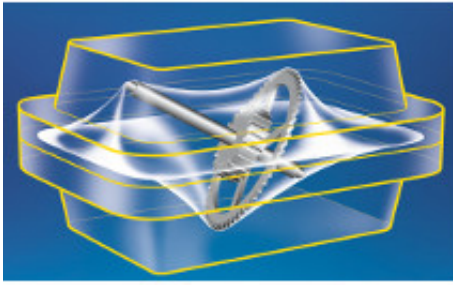

Schéma	Longueur (1) mm	Largeur (2) mm	Hauteur (3) mm	Référence	Quantité	
	150	150	8	222		S
			12.5	224		S
			25	225		S
			37.5	226		S
			50	227		S
			62.5	228		
	175	50	8	237		
			12.5	238		S
			25	239		S
	175	50	8	240		
			12.5	241		
	175	75	8	247		
			12.5	248		
	175	75	25	249		
			37.5	250		
			8	251		
	175	75	12.5	252		S
			25	253		S
			37.5	254		
	175	75	8	255		
			12.5	256		
			25	257		
			37.5	258		
	175	100	8	274		

- L = Crochet d'ouverture
- C = Charnière
- Les numéros d'article concernent toujours des ½ boîtes
- S = Livrable du stock (sans frais d'outillage)

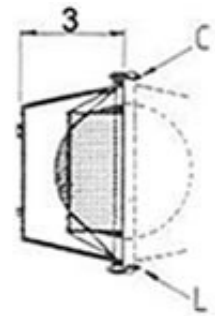
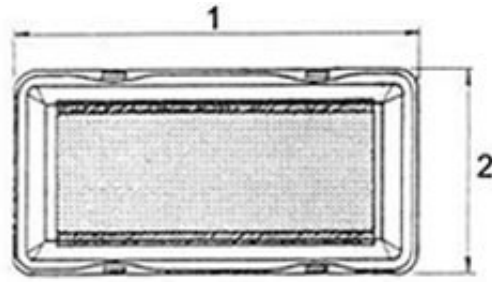
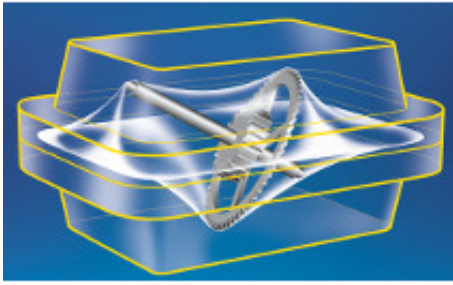

Schéma	Longueur (1) mm	Largeur (2) mm	Hauteur (3) mm	Référence	Quantité	
	175	100	12.5	275		S
			25	276		S
			37.5	277A		
			50	278		
	175	100	8	284A		
			12.5	285		S
			25	286		
			37.5	287		
	175	125	8	312		
			12.5	313		
			25	314		S
			37.5	315		S
			50	316		
	175	125	8	324		
			12.5	325		
			25	326		S
			37.5	327		S
			50	328		
			62.5	329		
	175	150	8	357		
			12.5	358		
			25	359		S
			37.5	360		
			50	361		
			62.5	362		
			75	363		

- L = Crochet d'ouverture
- C = Charnière
- Les numéros d'article concernent toujours des ½ boîtes
- S = Livrable du stock (sans frais d'outillage)

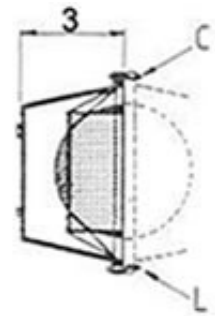
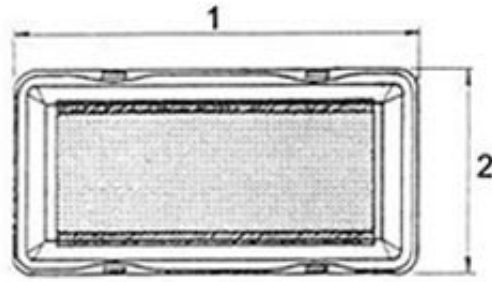
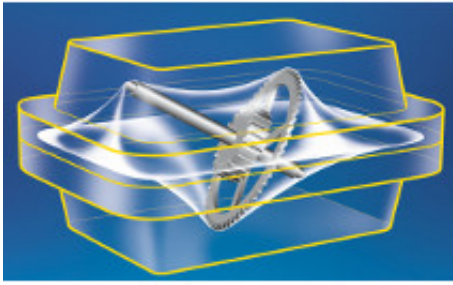

Schéma	Longueur (1) mm	Largeur (2) mm	Hauteur (3) mm	Référence	Quantité	
	175	150	8	371		
			12.5	372		
			25	373		S
			37.5	374		
			50	375		
			62.5	376		
			75	377		
	175	175	8	401		S
			12.5	402		
			25	403		S
			37.5	404		
			50	405		S
			62.5	406		
			75	407		
	175	175	8	409		S
			12.5	410		S
			25	411		S
			37.5	412		
			50	413		S
			62.5	414		
			75	415		S
	200	50	8	423		
			12.5	424		S
			25	425		S

- L = Crochet d'ouverture
- C = Charnière
- Les numéros d'article concernent toujours des 1/2 boîtes
- S = Livrable du stock (sans frais d'outillage)

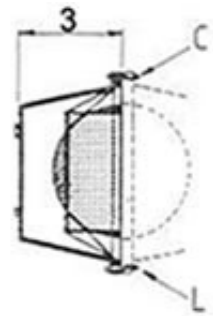
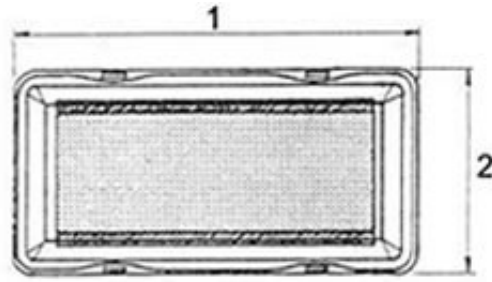
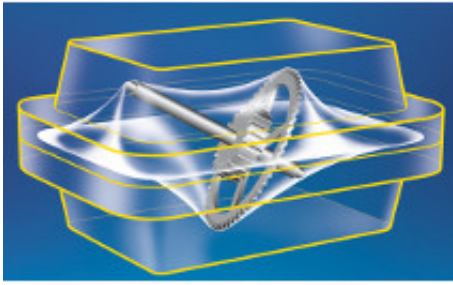

Schéma	Longueur (1) mm	Largeur (2) mm	Hauteur (3) mm	Référence	Quantité	
	200	50	8	426		
			12.5	427		S
			25	428		S
	200	75	8	437		
			12.5	438		S
			25	439		S
			37.5	440		S
	200	75	8	441		
			12.5	442		S
			25	443		S
	200	100	37.5	444		
			8	460		S
			12.5	461		
			25	462		S
			37.5	463		
	200	100	50	464		
			8	465		
			12.5	466		
			25	467		S
			37.5	468		S
	200	125	50	469		
			8	493		S
			12.5	494		
			25	495		
			37.5	496		
			50	497		
	200	125	62.5	498		

- L = Crochet d'ouverture
- C = Charnière
- Les numéros d'article concernent toujours des 1/2 boîtes
- S = Livrable du stock (sans frais d'outillage)

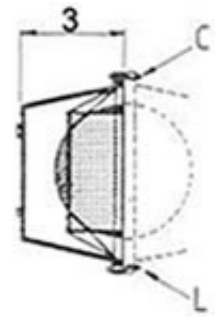
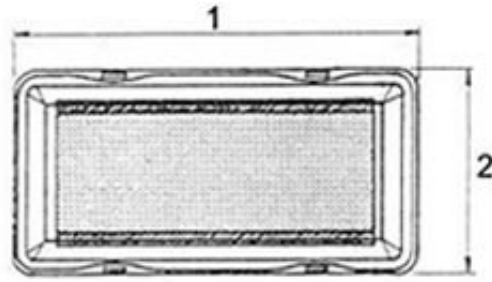
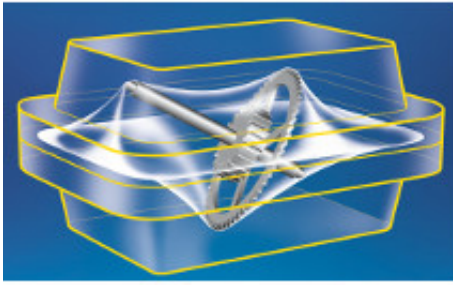

Schéma	Longueur (1) mm	Largeur (2) mm	Hauteur (3) mm	Référence	Quantité	
	200	125	8	505		S
			12.5	506		S
			25	507		S
			37.5	508		
			50	509		
			62.5	510		
	200	150	8	538		
			12.5	539		S
			25	540		S
			37.5	541		S
			50	542		S
			62.5	543		
			75	544		
	200	150	8	552		
			12.5	553		
			25	554		S
			37.5	555		S
			50	556		S
			62.5	557		
			75	558		
	200	175	8	590		
			12.5	591		
			25	592		S
			37.5	593		
			50	594		
			62.5	595		
			75	596		
			87.5	597		

- L = Crochet d'ouverture
- C = Charnière
- Les numéros d'article concernent toujours des ½ boîtes
- S = Livrable du stock (sans frais d'outillage)

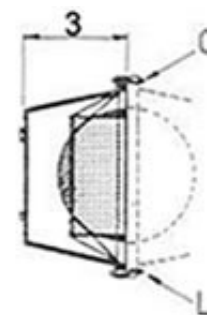
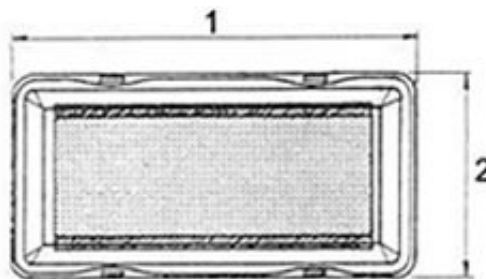
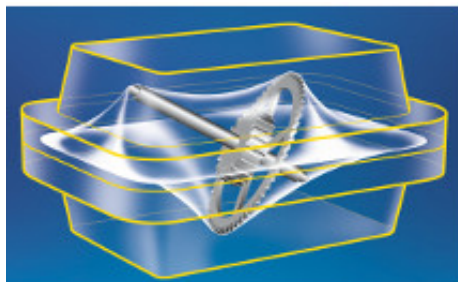

Schéma	Longueur (1) mm	Largeur (2) mm	Hauteur (3) mm	Référence	Quantité	
	200	175	8	606		
			12.5	607		
			25	608		S
			37.5	609		
			50	610		S
			62.5	611		
			75	612		
			87.5	613		
	200	200	8	640		
			12.5	641		S
			25	642		S
			37.5	643		
			50	644		
			62.5	645		
			75	646		
			87.5	647		
			100	648		
	200	200	8	649		S
			12.5	650		S
			25	651		S
			37.5	652		
			50	653		
			62.5	654		
			75	655		
			87.5	656		
			100	657		

- L = Crochet d'ouverture
- C = Charnière
- Les numéros d'article concernent toujours des 1/2 boîtes
- S = Livrable du stock (sans frais d'outillage)

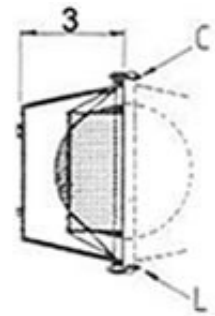
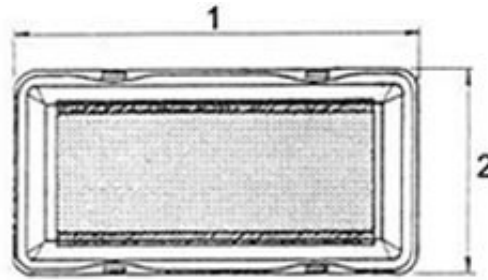
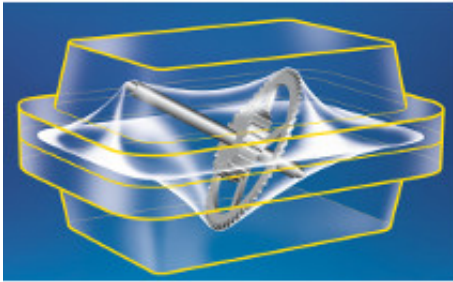

Schéma	Longueur (1) mm	Largeur (2) mm	Hauteur (3) mm	Référence	Quantité	
	225	50	8	664		
			12.5	665		
			25	666		
	225	50	8	667		
			12.5	668		
			25	669		S
	225	75	8	678		
			12.5	679		
			25	680		
			37.5	681		
	225	75	8	682		
			12.5	683		S
			25	684		
			37.5	685		
	225	100	8	701		
			12.5	702		
			25	703		
			37.5	704		
			50	705		
	225	100	8	706		
			12.5	707		
			25	708		S
			37.5	709		
			50	710		

- L = Crochet d'ouverture
- C = Charnière
- Les numéros d'article concernent toujours des ½ boîtes
- S = Livrable du stock (sans frais d'outillage)

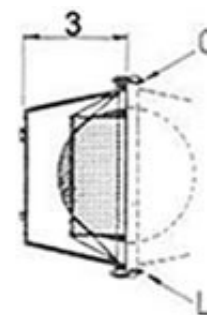
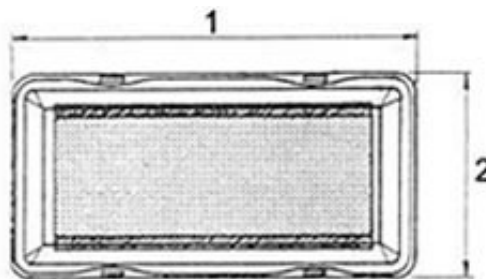
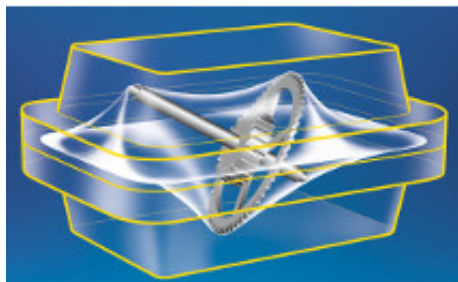

Schéma	Longueur (1) mm	Largeur (2) mm	Hauteur (3) mm	Référence	Quantité	
	225	125	8	736		
			12.5	737		S
			25	738		S
			37.5	739		
			50	740		
			62.5	741		
	225	125	8	748		
			12.5	749		S
			25	750		S
			37.5	751		
			50	752		
			62.5	753		
	225	150	8	781		
			12.5	782		
			25	783		
			37.5	784		
			50	785		
			62.5	786		
			75	787		
	225	150	8	795		
			12.5	796		
			25	797		S
			37.5	798		
			50	799		S
			62.5	800		
			75	801		

- L = Crochet d'ouverture
- C = Charnière
- Les numéros d'article concernent toujours des 1/2 boîtes
- S = Livrable du stock (sans frais d'outillage)

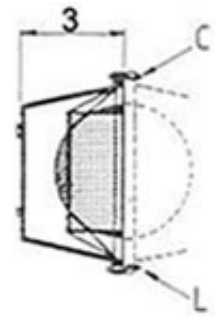
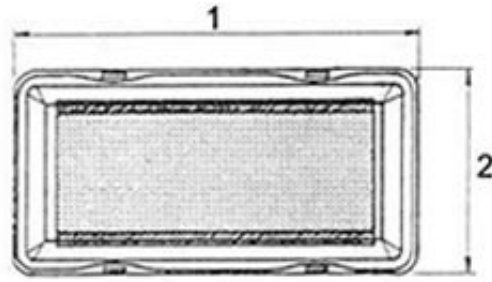
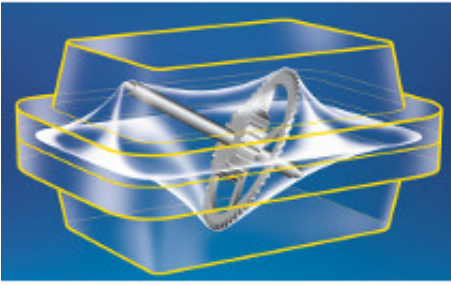

Schéma	Longueur (1) mm	Largeur (2) mm	Hauteur (3) mm	Référence	Quantité
	225	175	8	833	
			12.5	834	
			25	835	
			37.5	836	
			50	837	
			62.5	838	
			75	839	
			87.5	840	
	225	175	8	849	
			12.5	850	
			25	851	S
			37.5	852	
			50	853	
			62.5	854	
			75	855	
			87.5	856	
	225	200	8	892	
			12.5	893	
			25	894	S
			37.5	895	
			50	896	
			62.5	897	
			75	898	
			87.5	899	
		100	900		

- L = Crochet d'ouverture
- C = Charnière
- Les numéros d'article concernent toujours des ½ boîtes
- S = Livrable du stock (sans frais d'outillage)

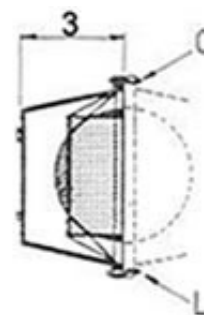
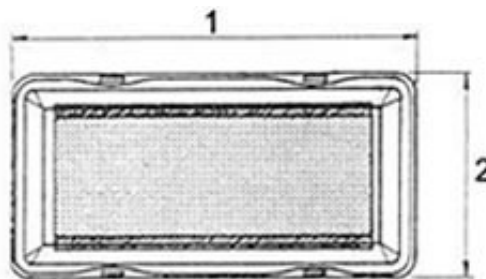
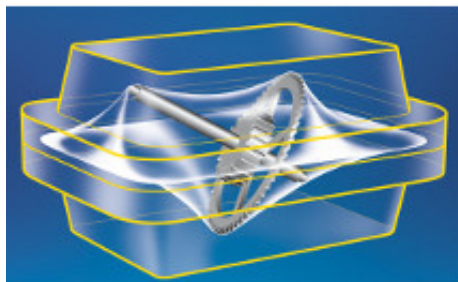

Schéma	Longueur (1) mm	Largeur (2) mm	Hauteur (3) mm	Référence	Quantité	
	225	200	8	910		
			12.5	911		S
			25	912		S
			37.5	913		
			50	914		
			62.5	915		
			75	916		
			87.5	917		
100	918					
	250	50	8	934		S
			12.5	935		
			25	936		S
	250	50	8	937		
			12.5	938		
			25	939		S
	250	75	8	948		
			12.5	949		
			25	950		
	250	75	37.5	951		
			8	952		
			12.5	953		S
	250	100	25	954		
			37.5	955		
			8	971		S
			12.5	972		S
			25	973		S
	250	100	37.5	974		
			50	975		

- L = Crochet d'ouverture
- C = Charnière
- Les numéros d'article concernent toujours des ½ boîtes
- S = Livrable du stock (sans frais d'outillage)

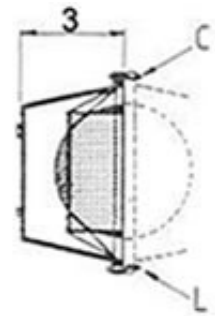
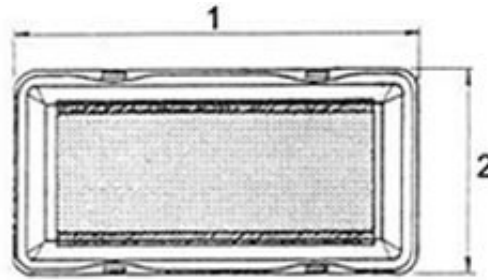
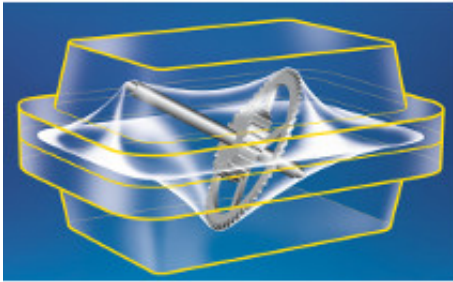

Schéma	Longueur (1) mm	Largeur (2) mm	Hauteur (3) mm	Référence	Quantité	
	250	100	8	976		
			12.5	977		S
			25	978		S
			37.5	979		
			50	980		S
	250	125	8	1004		S
			12.5	1005		
			25	1006		
			37.5	1007		
			50	1008		
			62.5	1009		
	250	125	8	1016		S
			12.5	1017		S
			25	1018		S
			37.5	1019		
			50	1020		
			62.5	1021		
	250	150	8	1049		
			12.5	1050		
			25	1051		
			37.5	1052		
			50	1053		
			62.5	1054		
			75	1055		

- L = Crochet d'ouverture
- C = Charnière
- Les numéros d'article concernent toujours des ½ boîtes
- S = Livrable du stock (sans frais d'outillage)

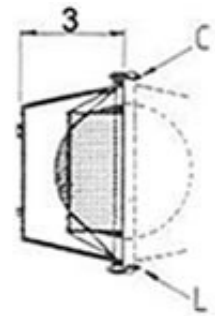
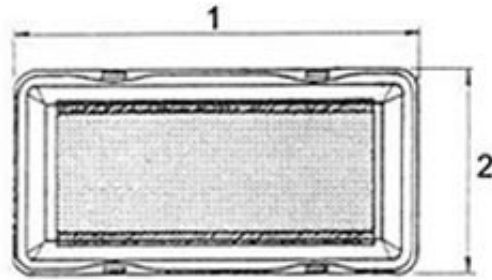
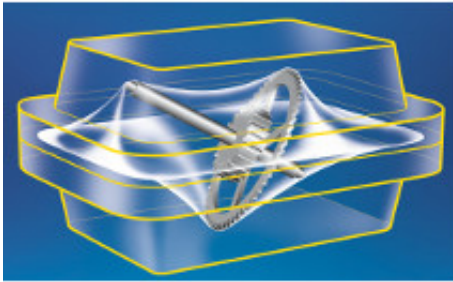

Schéma	Longueur (1) mm	Largeur (2) mm	Hauteur (3) mm	Référence	Quantité	
	250	150	8	1063		S
			12.5	1064		
			25	1065		S
			37.5	1066		S
			50	1067		
			62.5	1068		
			75	1069		
	250	175	8	1101		
			12.5	1102		
			25	1103		
			37.5	1104		
			50	1105		
			62.5	1106		
			75	1107		
	250	175	8	1117		
			12.5	1118		
			25	1119		S
			37.5	1120		
			50	1121		
			62.5	1122		
			75	1123		
		87.5	1124			

- L = Crochet d'ouverture
- C = Charnière
- Les numéros d'article concernent toujours des ½ boîtes
- S = Livrable du stock (sans frais d'outillage)

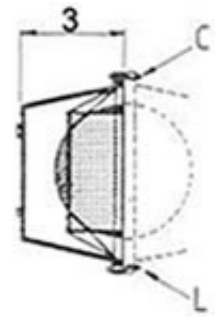
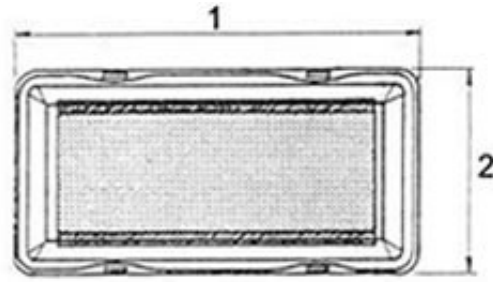
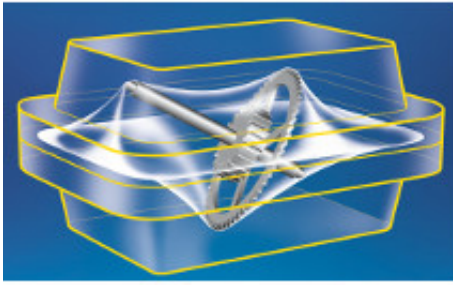

Schéma	Longueur (1) mm	Largeur (2) mm	Hauteur (3) mm	Référence	Quantité
	250	200	8	1160	
			12.5	1161	
			25	1162	
			37.5	1163	
			50	1164	
			62.5	1165	
			75	1166	
			87.5	1167	
	250	200	8	1178	
			12.5	1179	S
			25	1180	S
			37.5	1181	S
			50	1182	S
			62.5	1183	
			75	1184	
			87.5	1185	
	275	50	8	1202	
			12.5	1203 A	
			25	1204	
	275	50	8	1205 A	
			12.5	1206	
			25	1207	S
	275	75	8	1216 A	
			12.5	1217	
			25	1218	
			37.5	1219	

- L = Crochet d'ouverture
- C = Charnière
- Les numéros d'article concernent toujours des ½ boîtes
- S = Livrable du stock (sans frais d'outillage)

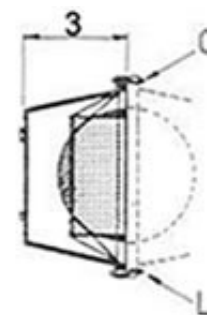
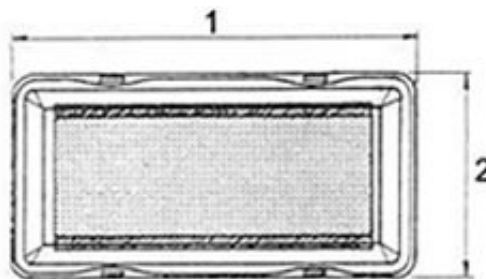
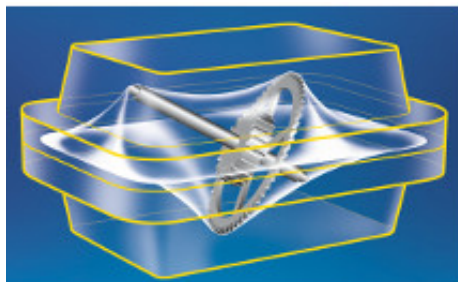

Schéma	Longueur (1) mm	Largeur (2) mm	Hauteur (3) mm	Référence	Quantité	
	275	75	8	1220 A		
			12.5	1221		S
			25	1222 A		
			37.5	1223 A		
	275	100	8	1239		
			12.5	1240 A		
			25	1241		S
			37.5	1242		
			50	1243		
	275	100	8	1244		S
			12.5	1245 A		
			25	1246 A		S
			37.5	1247		S
			50	1248 A		
	275	125	8	1267		
			12.5	1268		S
			25	1269		
			37.5	1270		
			50	1271		
			62.5	1272 A		
	275	125	8	1279 A		
			12.5	1280 A		
			25	1281		S
			37.5	1282		S
			50	1283		
			62.5	1284		

- L = Crochet d'ouverture
- C = Charnière
- Les numéros d'article concernent toujours des ½ boîtes
- S = Livrable du stock (sans frais d'outillage)

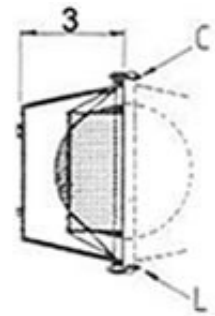
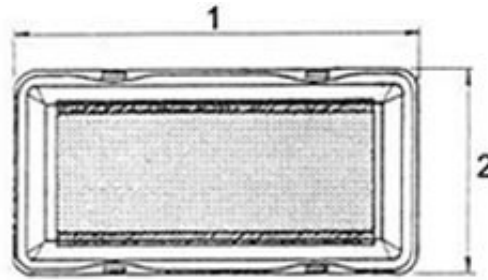
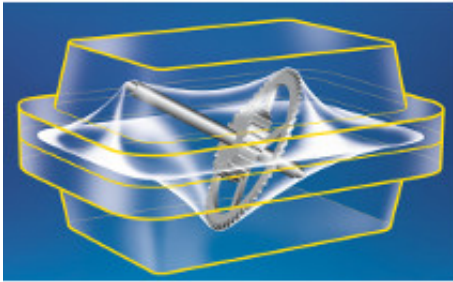

Schéma	Longueur (1) mm	Largeur (2) mm	Hauteur (3) mm	Référence	Quantité
	275	150	8	1312	
			12.5	1313	
			25	1314	
			37.5	1315	
			50	1316	
			62.5	1317	
			75	1318	
	275	150	8	1326	
			12.5	1327	
			25	1328	S
			37.5	1329	
			50	1330	
			62.5	1331	
			75	1332	
	275	175	8	1364	
			12.5	1365	
			25	1366	
			37.5	1367	
			50	1368	
			62.5	1369	
			75	1370A	
	275	175	8	1380	
			12.5	1381	
			25	1382	
			37.5	1383	
			50	1384	
			62.5	1385	
			75	1386	
			87.5	1387	

- L = Crochet d'ouverture
- C = Charnière
- Les numéros d'article concernent toujours des ½ boîtes
- S = Livrable du stock (sans frais d'outillage)

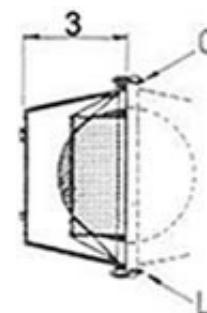
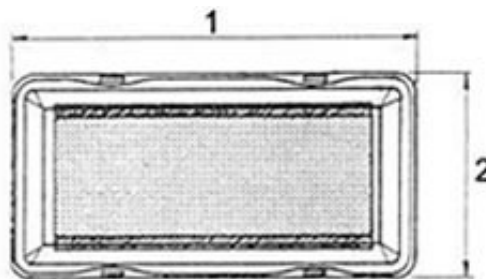
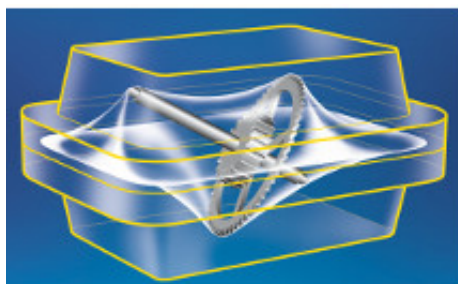

Schéma	Longueur (1) mm	Largeur (2) mm	Hauteur (3) mm	Référence	Quantité
	275	200	8	1441	
			12.5	1442	
			25	1443	S
			37.5	1444	S
			50	1445	S
			62.5	1446	
			75	1447	S
			87.5	1448	
			100	1449	S
	300	50	8	1465	
			12.5	1466	
			25	1467	S
	300	75	8	1483	
			12.5	1484.1	S
			25	1485.1	S
	300	100	8	1502	
			12.5	1503	
			25	1504	S
			37.5	1505	
			50	1506	
	300	100	8	1507	
			12.5	1508	
			25	1509	S
			37.5	1510	
			50	1511	S

- L = Crochet d'ouverture
- C = Charnière
- Les numéros d'article concernent toujours des ½ boîtes
- S = Livrable du stock (sans frais d'outillage)



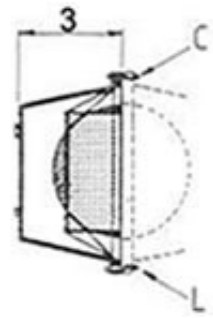
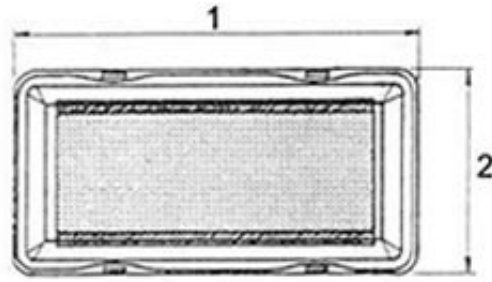
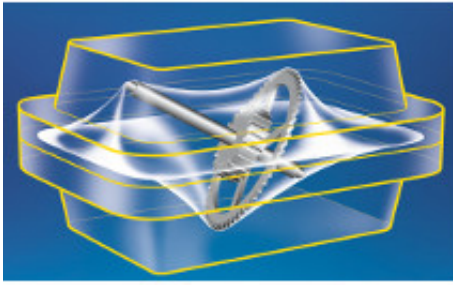

Schéma	Longueur (1) mm	Largeur (2) mm	Hauteur (3) mm	Référence	Quantité	
	300	125	8	1530		
			12.5	1531		
			25	1532		S
			50	1534		
			62.5	1535		
	300	125	37.5	1533.1		S
	300	125	8	1542		
			12.5	1543		
			25	1544		S
			37.5	1545		
			50	1546		
			62.5	1547		
	300	150	8	1575		
			12.5	1576		
			25	1577		
			37.5	1578		S
			50	1579		
			62.5	1580		
			75	1581		
	300	150	8	1589		S
			12.5	1590		S
			25	1591		S
			37.5	1592		S
			50	1593		
			62.5	1594		
			75	1595		

- L = Crochet d'ouverture
- C = Charnière
- Les numéros d'article concernent toujours des ½ boîtes
- S = Livrable du stock (sans frais d'outillage)

Schéma	Longueur (1) mm	Largeur (2) mm	Hauteur (3) mm	Référence	Quantité	
	300	150	8	1603		S
			12.5	1604		S
			25	1605		S
			37.5	1606		S
			50	1607		
			62.5	1608		
			75	1609		
	350	200	8	2318		
			12.5	2319		S
			25	2320		S
			37.5	2321		S
			50	2322		

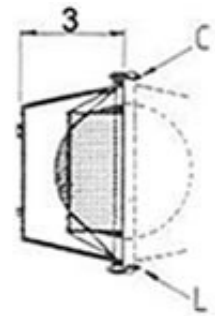
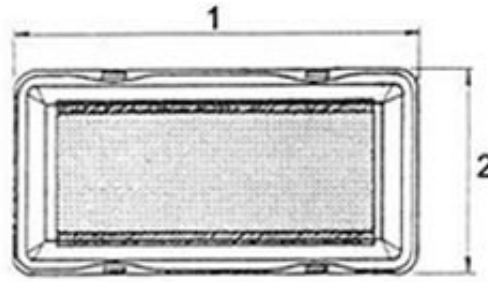
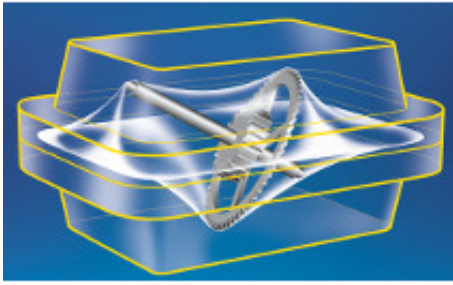
- L = Crochet d'ouverture
- C = Charnière
- Les numéros d'article concernent toujours des ½ boîtes
- S = Livrable du stock (sans frais d'outillage)

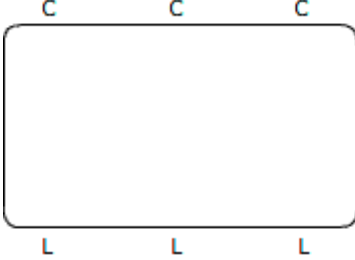

Schéma	Longueur (1) mm	Largeur (2) mm	Hauteur (3) mm	Référence	Quantité	
	300	300	12.5	2324		
			25	2325		S
			37.5	2326		
	400	200	12.5	2608		
			25	2609		S
			37.5	2610		
	400	300	12.5	2632		
			25	2633		S
			37.5	2634		
	400	400	12.5	2656		
			25	2657		S
			37.5	2658		

Schéma	Longueur (1) mm	Largeur (2) mm	Hauteur (3) mm	Référence	Quantité	
	500	200	12.5	3004		
			25	3005		S
			37.5	3006		
	500	300	12.5	3028		
			25	3029		S
			37.5	3030		
	500	400	12.5	3052		
			25	3054		S
			37.5	3055		
	500	500	12.5	3076		
			25	3077		S
			37.5	3078		

Schéma	Longueur (1) mm	Largeur (2) mm	Hauteur (3) mm	Référence	Quantité
	600	200	12.5	3496	
			25	3497	S
			37.5	3498	
	600	300	12.5	3520	
			25	3521	S
			37.5	3522	
	600	400	12.5	3544	
			25	3545	S
			37.5	3546	

- L = Crochet d'ouverture
- C = Charnière
- Les numéros d'article concernent toujours des ½ boîtes
- S = Livrable du stock (sans frais d'outillage)

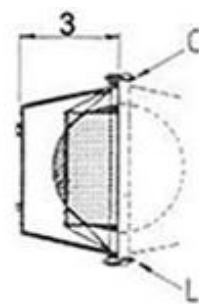
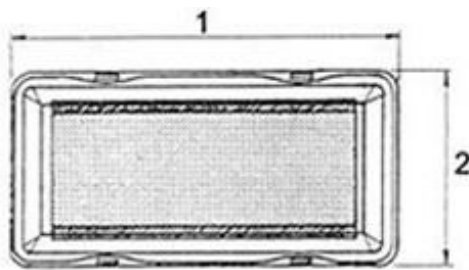

Schéma	Longueur mm	Largeur mm	Hauteur mm	Référence	Quantité	
	100	75	12.5	23 CAN		S
			25	24 CAN		S
			37.5	25 CAN		S
	125	125	12.5	97 CAN		S
			25	98 CAN		S
			37.5	99 CAN		S
	150	75	12.5	129 CAN		S
			25	130 CAN		S
	150	150	12.5	224 CAN		S
			25	225 CAN		S
			32.5	226 CAN		S
	175	75	12.5	252 CAN		S
			25	253 CAN		S
	175	100	12.5	275 CAN		S
			25	276 CAN		S
	200	150	12.5	539 CAN		S
			25	540 CAN		S
			37.5	541 CAN		S
			50	542 CAN		S

- L = Crochet d'ouverture
- C = Charnière
- Les numéros d'article concernent toujours des ½ boîtes
- S = Livrable du stock (sans frais d'outillage)

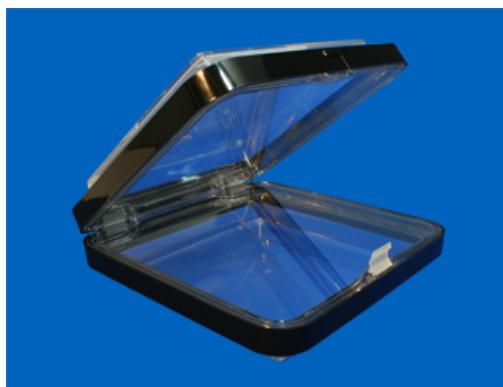

Schéma	Longueur mm	Largeur mm	Hauteur mm	Référence	Quantité	
	100	75	12.5	23 CAB		S
			25	24 CAB		S
			37.5	25 CAB		S
	125	125	12.5	97 CAB		S
			25	98 CAB		S
			37.5	99 CAB		S
	150	75	12.5	129 CAB		S
			25	130 CAB		S
	150	150	12.5	224 CAB		S
			25	225 CAB		S
			32.5	226 CAB		S
	175	75	12.5	252 CAB		S
			25	253 CAB		S
	175	100	12.5	275 CAB		S
			25	276 CAB		S
	200	150	12.5	539 CAB		S
			25	540 CAB		S
			37.5	541 CAB		S
			50	542 CAB		S

- L = Crochet d'ouverture
 - C = Charnière
 - Les numéros d'article concernent toujours des ½ boîtes
 - S = Livrable du stock (sans frais d'outillage)

Boîte à membrane pour montres avec bracelet métallique et cuir

23c

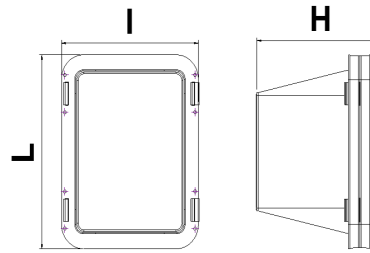

80.1T Boîte à membrane pour montre avec bracelet métallique et cuir (transport)

Longueur(L) en mm	largeur (l) en mm	Hauteur (H) en mm	Poids en Gr	Diamètre intérieur du bracelet en mm	Quantité
125	100	87.5	120	du 57 au 68	

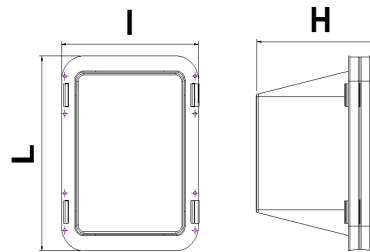

80.1CAB Boîte à membrane de présentation avec cadre blanc pour montre avec bracelet métallique et cuir

Longueur (L) mm	largeur (l) mm	Hauteur (H) mm	Poids en Gr	Diamètre intérieur du bracelet en mm	Quantité
125	100	87.5	150	du 57 au 68	

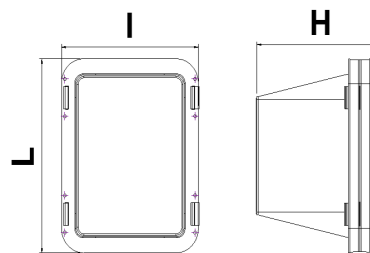

80.1CAN Boîte à membrane de présentation avec cadre noir pour montre avec bracelet métallique et cuir

Longueur (L) mm	largeur (l) mm	Hauteur (H) mm	Poids en Gr	Diamètre intérieur du bracelet en mm	Quantité
125	100	87.5	150	du 57 au 68	



Schéma	d mm	e mm	f mm	Ø mm	g gr.	Longueur (1) mm	Largeur ((2) mm	Hauteur (3) mm	Référence	Quantité
	18	18	9	25	10	240	79	17.8	12.12T	S
	18	18	9	25	10	120	79	17.8	12.12.T11	S
	18	18	9	25	10	39	39	17.8	12.12T4	S

- positions 12.12 T et 12.12 T 11 se livrent en grappe fond et couvercle séparés.
- position 12.12 T 4 se livre par pièce fond et couvercle ensemble en sachet de 100 ou 200 pièces .
- S = Livrable du stock (sans frais d'outillage)
- g : poids maximum de l'objet emballé.





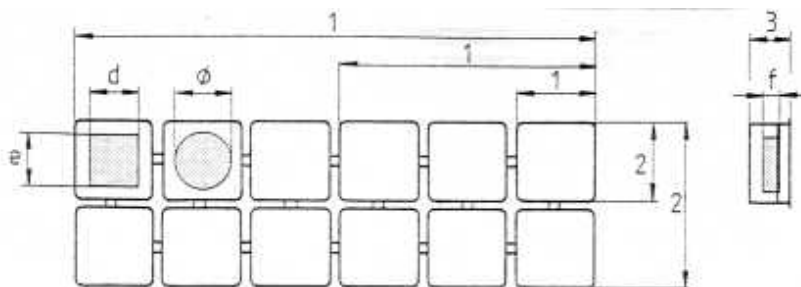

Schéma	d	e	f	Ø	g	Hauteur (1) mm	Ø (2) mm	Référence	Quantité
	mm	mm	mm	mm	gr.				
	40	40	9	54	100	17	82	17.82.1	S
	40	40	20	54	200	40	82	40.82.1	S
	77	77	20	108	900	42	165	42.165.1	S
	77	77	40	108	1800	84	165	84.165.1	S

- positions 17.82.1 et 40.82.1 se livrent fond et couvercle séparés.
- positions 42.165.1 et 84.165.1 se livrent fond et couvercle ensemble.
- g : poids maximum de l'objet emballé.
- S = Livrable du stock (sans frais d'outillage)

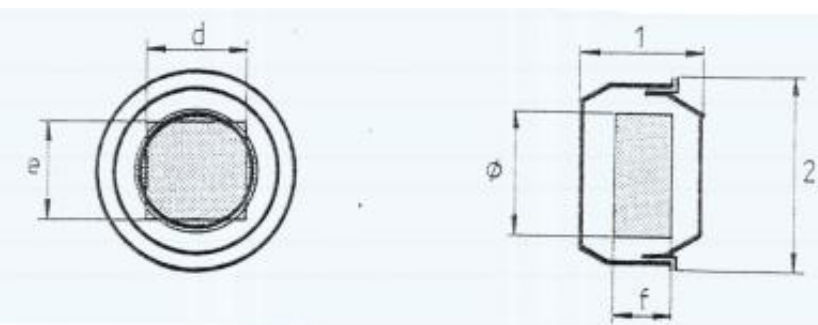
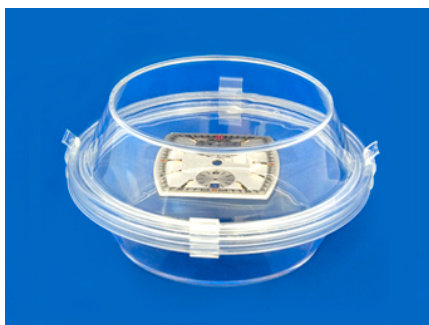

Schéma	Hauteur (1) mm	Diamètre(Ø) mm	Référence	Quantité
	12.5	100	12.5.100.1	
	12.5	150	12.5.150.1	

- L = Crochet d'ouverture
 - C = Charnière

- se livrent fond et couvercle ensemble
 - S = Livrable du stock (sans frais d'outillage)

	250	150	4	25	1016R		S
--	-----	-----	---	----	-------	--	---

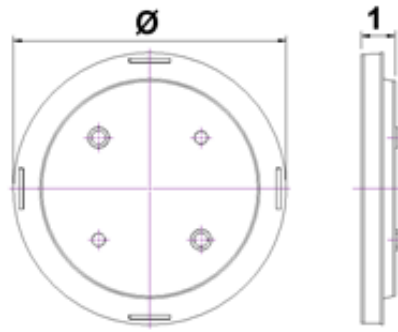
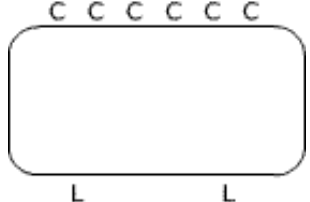
- L = Crochet d'ouverture
- C = Charnière

- se livrent fond et couvercle ensemble
- S = Livrable du stock (sans frais d'outillage)



Schéma	Longueur (1) mm	Largeur (2) mm	Hauteur (3) mm	Rayon(R) mm	Référence	Quantité
	125	100	12.5	50	12.5.100.125.1	
	150	100	12.5	50	12.5.100.150.1	
	175	100	12.5	50	12.5.100.175.1	
	175	150	12.5	75	12.5.150.175.1	
	200	100	12.5	50	12.5.100.200.1	
	200	150	12.5	75	12.5.150.200.1	
	225	100	12.5	50	12.5.100.225.1	
	225	150	12.5	75	12.5.150.225.1	
	250	100	12.5	50	12.5.100.250.1	

	250	150	12.5	75	12.5.150.250.1		
--	-----	-----	------	----	----------------	--	--

- L = Crochet d'ouverture
- C = Charnière

- se livrent fond et couvercle ensemble
- S = Livrable du stock (sans frais d'outillage)

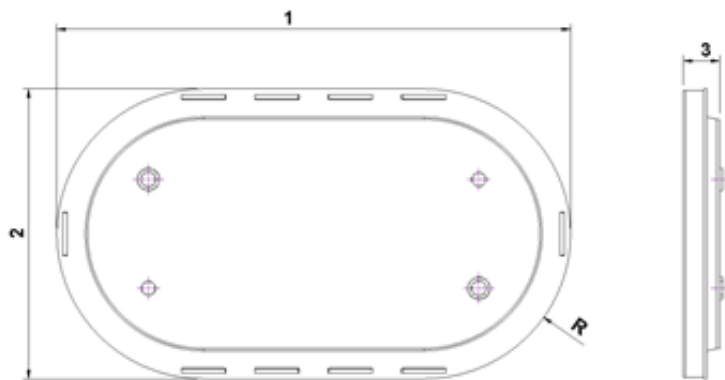

Schéma	Longueur (1) mm	Largeur (2) mm	Hauteur (3) mm	Référence	Quantité	
	150	125	37.5	198 E		S
	275	125	37.5	1282 E		S

Les ½ boîtes à membrane des pages 3 - 22 peuvent être construites en modèle étanche. Demandez une offre par mail (contact@swiss-boxes.ch) en indiquant le numéro de la ½ boîte à membrane que vous désirez en modèle étanche.

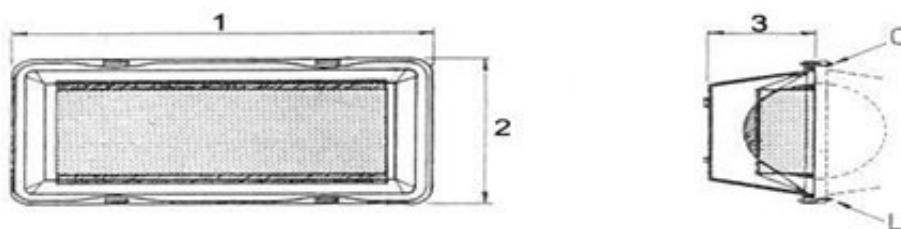
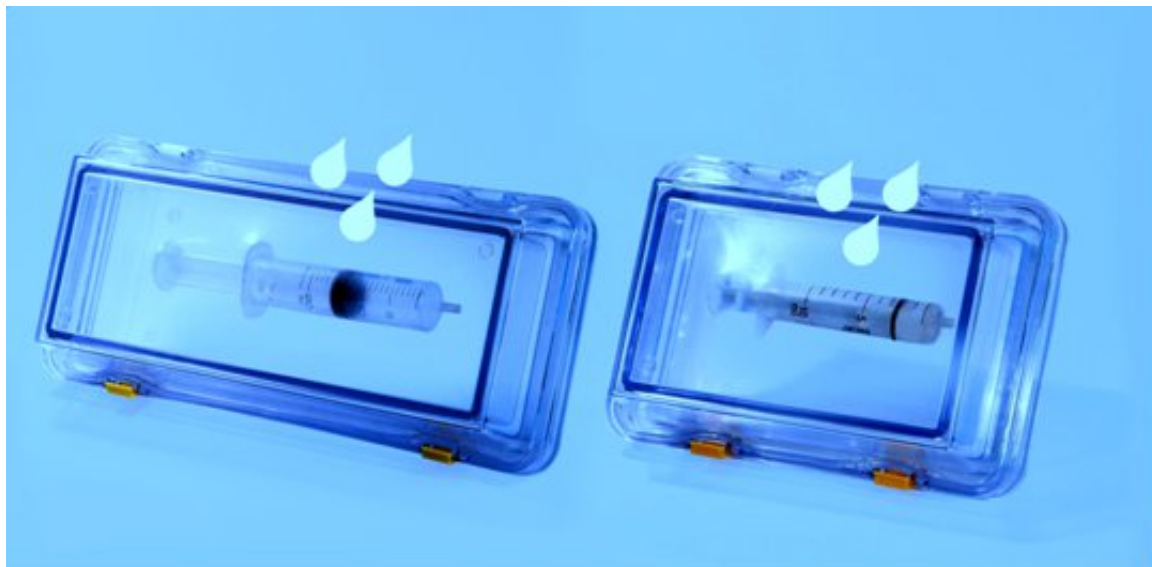
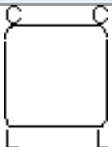
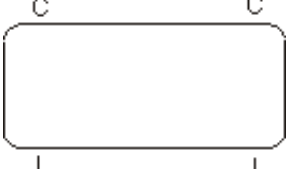
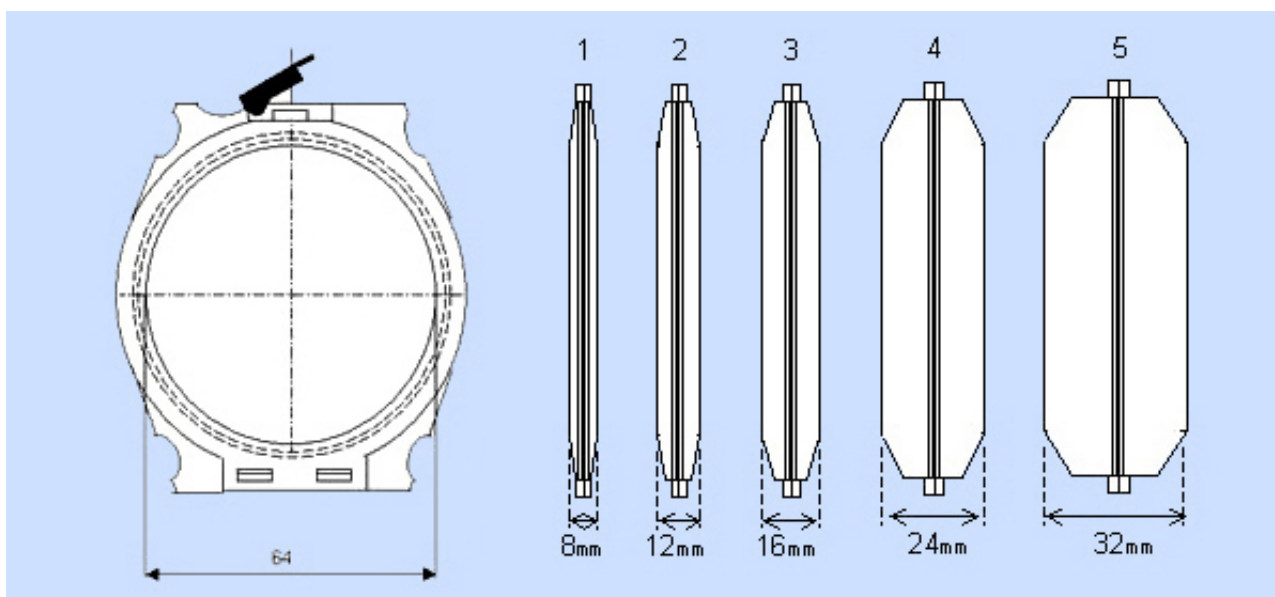
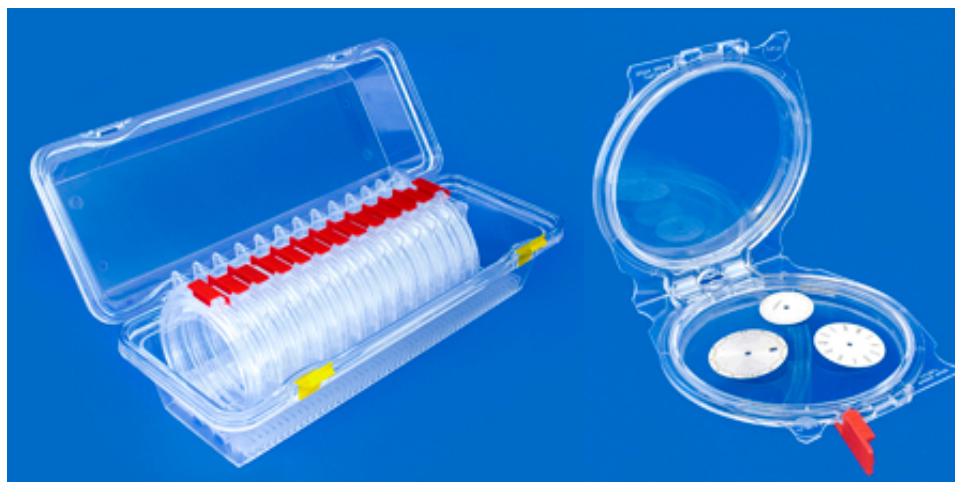

Désignation	Epaisseur mm	Référence	Quantité de cadres dans la boîte de conditionnement	Poids g.	Quantité
Cadres pliables	2 x 4 = 8	8.76	25	12.5	S
Cadres pliables	2 x 6 = 12	12.76	17	13	S
Cadres pliables	2 x 8 = 16	16.76	12	15	S
Cadres pliables	2 x 12 = 24	24.76	8	18	S
Cadres pliables	2 x 16 = 32	32.76	6	21	S
Boîte de conditionnement	40 (couvercle)	1247 B		253	S
	50 (fond)	1248.1			S

- **Remarque:** les cadres pliables peuvent être livrés avec cocque dure également.
 - S = Livrable du stock (sans frais d'outillage)

Boîte à membrane avec piton pour un cadran d'un diamètre maximum de 40 mm



Schéma	Longueur (1) mm	Largeur (2) mm	Hauteur (3) mm	Référence	Quantité	
	75	75	16	7.C		S
	75	75	8	7.RCE		S

Remarque: Toutes les références de boîtes suivies d'un E sont étanches
- S = Livrable du stock (sans frais d'outillage)

Cadre pliable avec piton pour un cadran d'un diamètre maximum de 50 mm

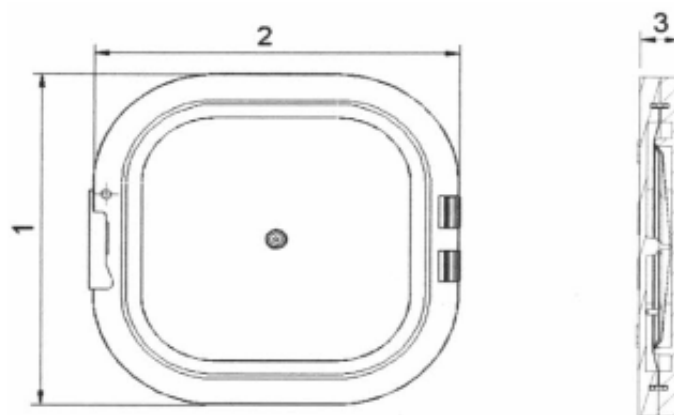
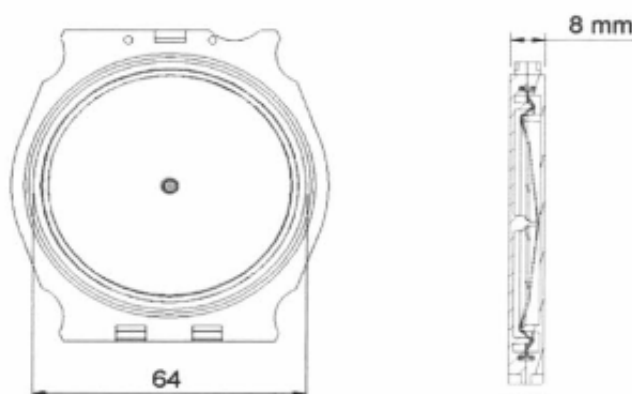

Désignation	Epaisseur mm	Référence	Quantité de cadres dans la boîte de conditionnement	Poids g.	Quantité	
Cadres pliables	2 x 4 = 8	8.76E	25	12.5		S
Boîte de conditionnement	40 (couvercle)	1247 B		253		S
	50 (fond)	1248.1				S

Remarque: Toutes les références de boîtes suivies d'un E sont étanches
- S = Livrable du stock (sans frais d'outillage)

Boîte à une membrane avec pitons pour 10/20/30 cadrans

25c



Schéma	Longueur (1) mm	Largeur (2) mm	Hauteur mm	Référence	Quantité	
	250	125	16	1016 B 10		S
			16	1016 B 20		S
			16	1016 B 30		S

Remarque: Chaque cadran est tenu en place par un piton. La membrane du couvercle maintient le cadran en place sans le rayer

- L = Crochet d'ouverture
- C = Charnière
- S = Livrable du stock (sans frais d'outillage)

Boîte à deux membranes avec pitons pour 10/20/30 cadrans

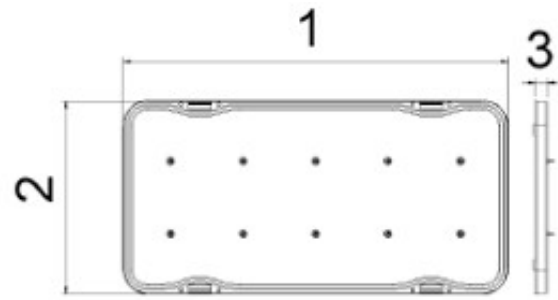
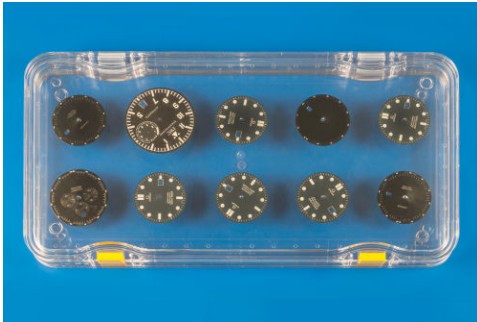
25d



Schéma	Longueur (1) mm	Largeur (2) mm	Hauteur mm	Référence	Quantité	
	250	125	8	1016 B 10.1		S
			8	1016 B 20.1		S
			8	1016 B 30.1		S

Remarque: Chaque cadran est tenu en place par un piton. La membrane du couvercle maintient le cadran en place sans le rayer

- L = Crochet d'ouverture
- C = Charnière
- S = Livrable du stock (sans frais d'outillage)

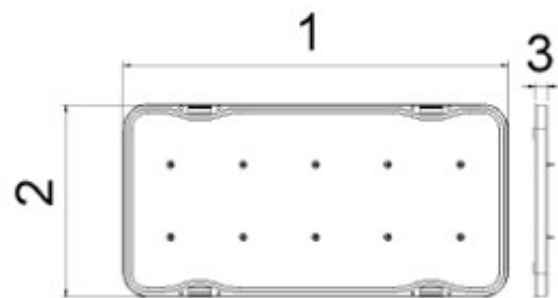
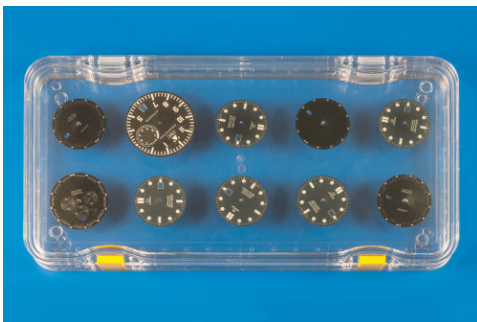
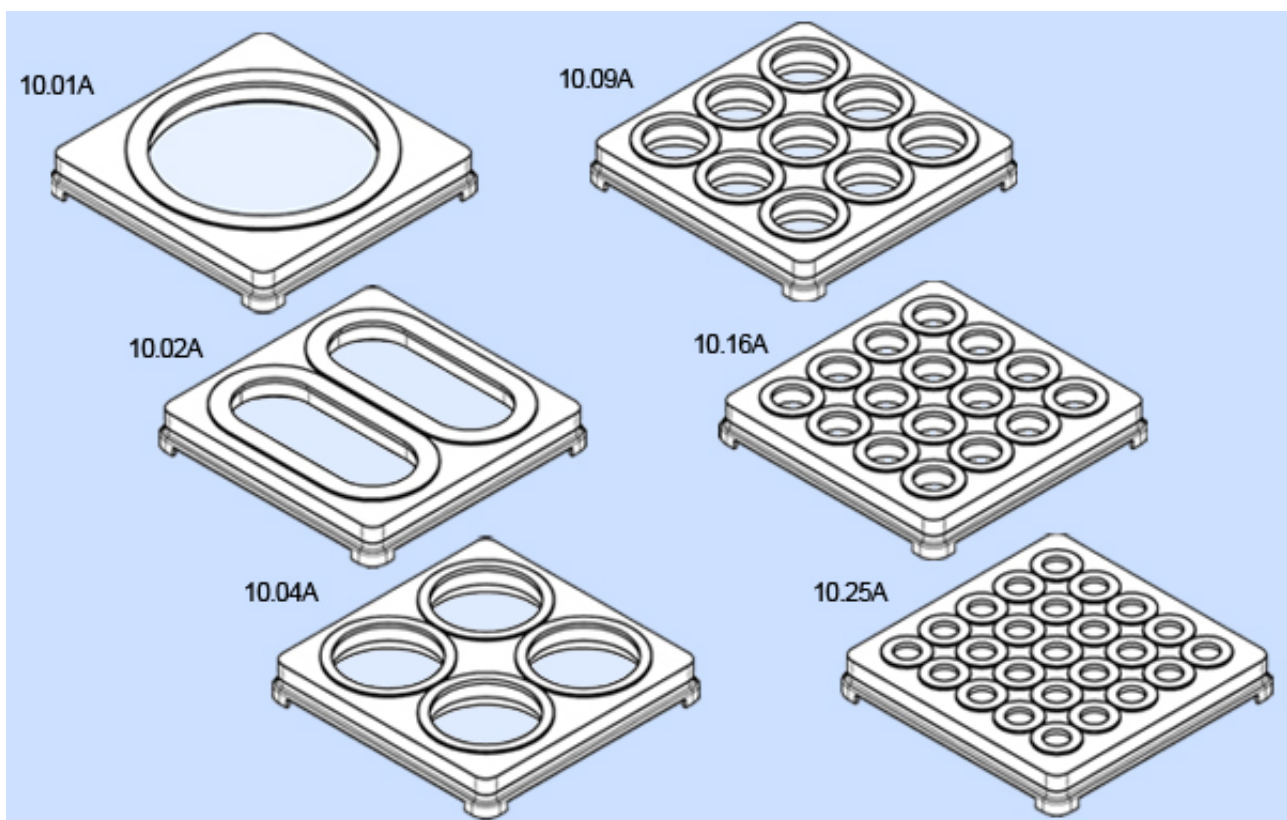

Référence	Plateaux empilables à deux membranes mm	Nb de cavités	Dimensions des cavités mm	Poids g	Quantité
10.01A	75 x 75 x 10	1	ø 45 x 6.5	18	S
10.02A	75 x 75 x 10	2	45 x 17 x 6.5	20	S
10.04A	75 x 75 x 10	4	ø 17 x 6.5	24	S
10.09A	75 x 75 x 10	9	ø 12.5 x 5	27	S
10.16A	75 x 75 x 10	16	ø 7.5 x 5	31	
10.25A	75 x 75 x 10	25	ø 5 x 5	33	

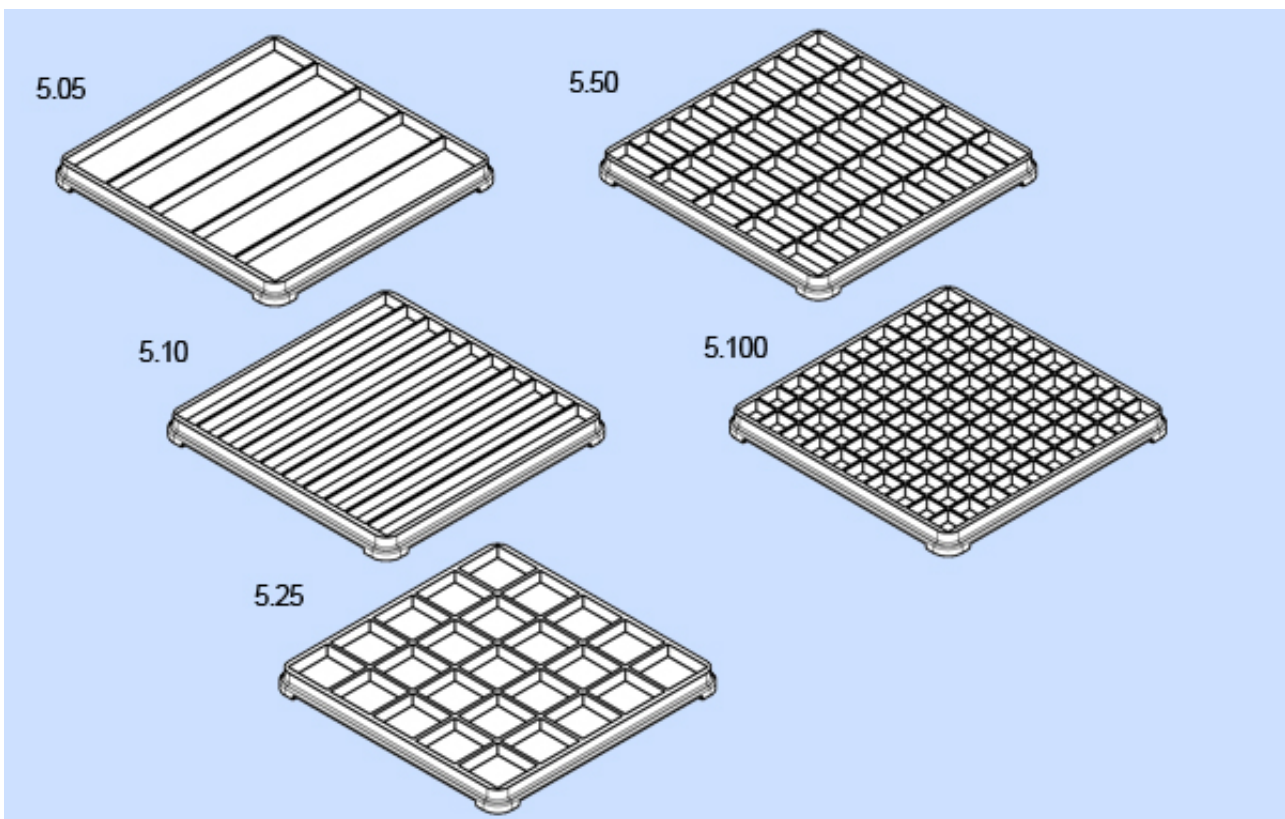
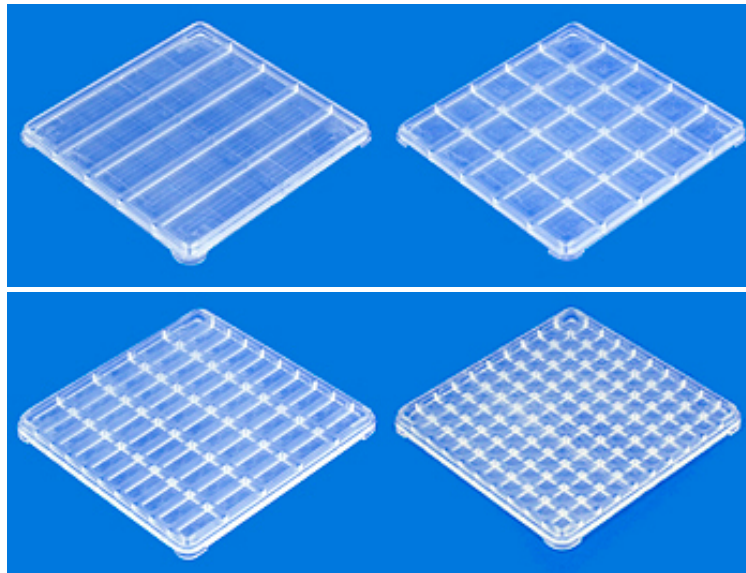

Référence	Plateaux empilables mm	Nb de cavités	Dimensions des cavités mm	Poids g	Quantité
5.05	75 x 75 x 5	5	69 x 13 x 3.7	9.6	S
5.10	75 x 75 x 5	10	69 x 6 x 3.7	10.6	S
5.25	75 x 75 x 5	25	13 x 13 x 3.7	10.4	S
5.50	75 x 75 x 5	50	13 x 6 x 3.7	11.4	S
5.100	75 x 75 x 5	100	6 x 6 x 3.7	12.3	S

- S = Livrable du stock (sans frais d'outillage)

